

1

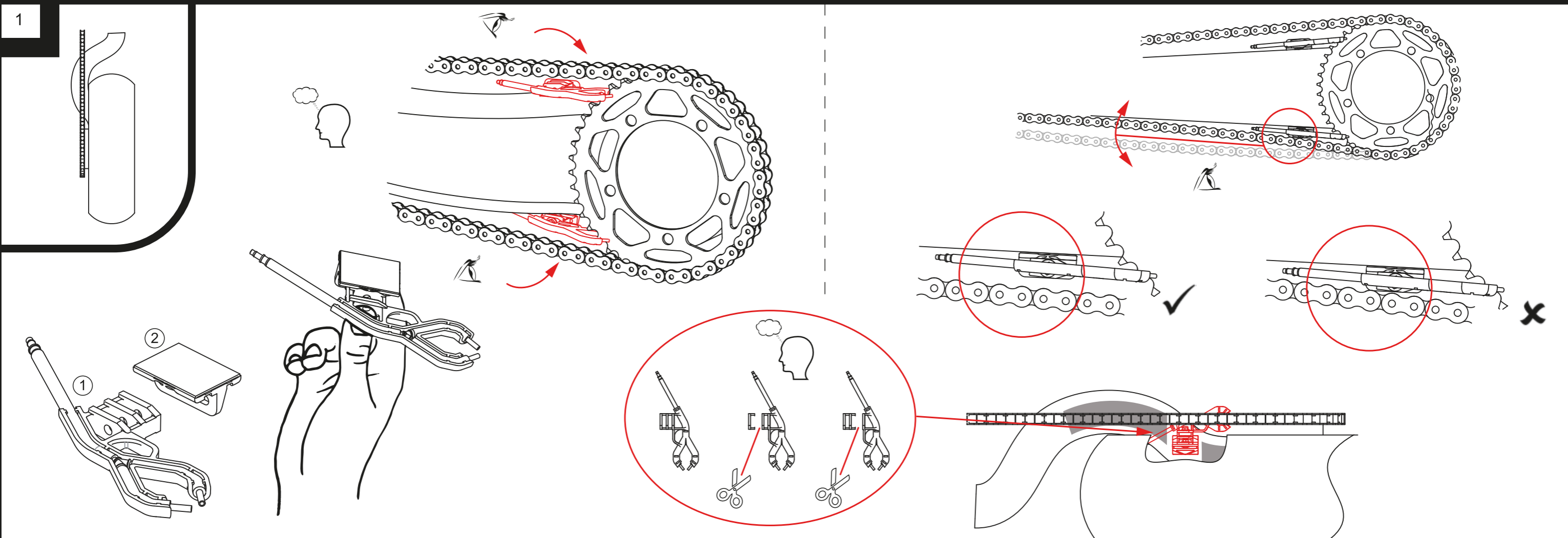

2

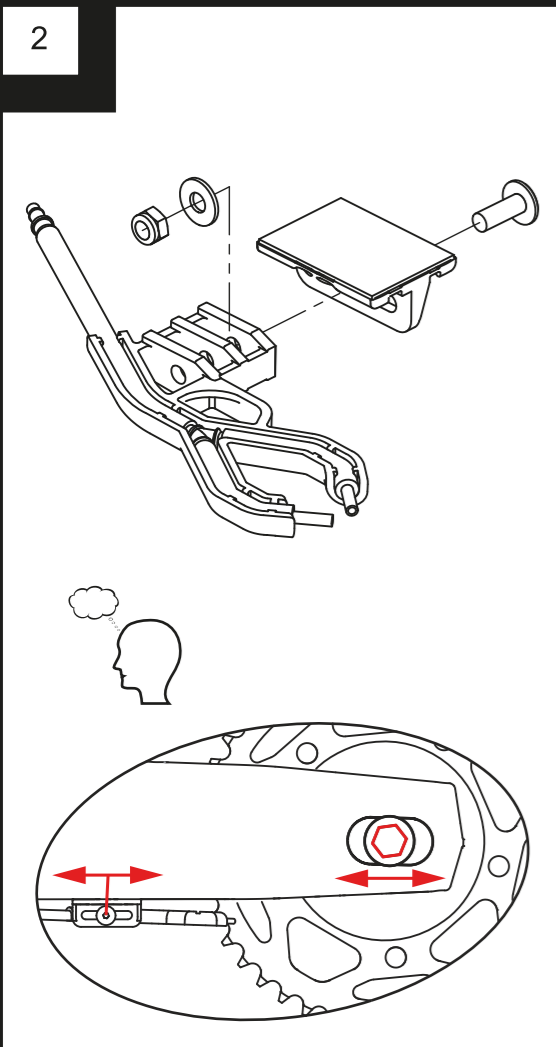

3

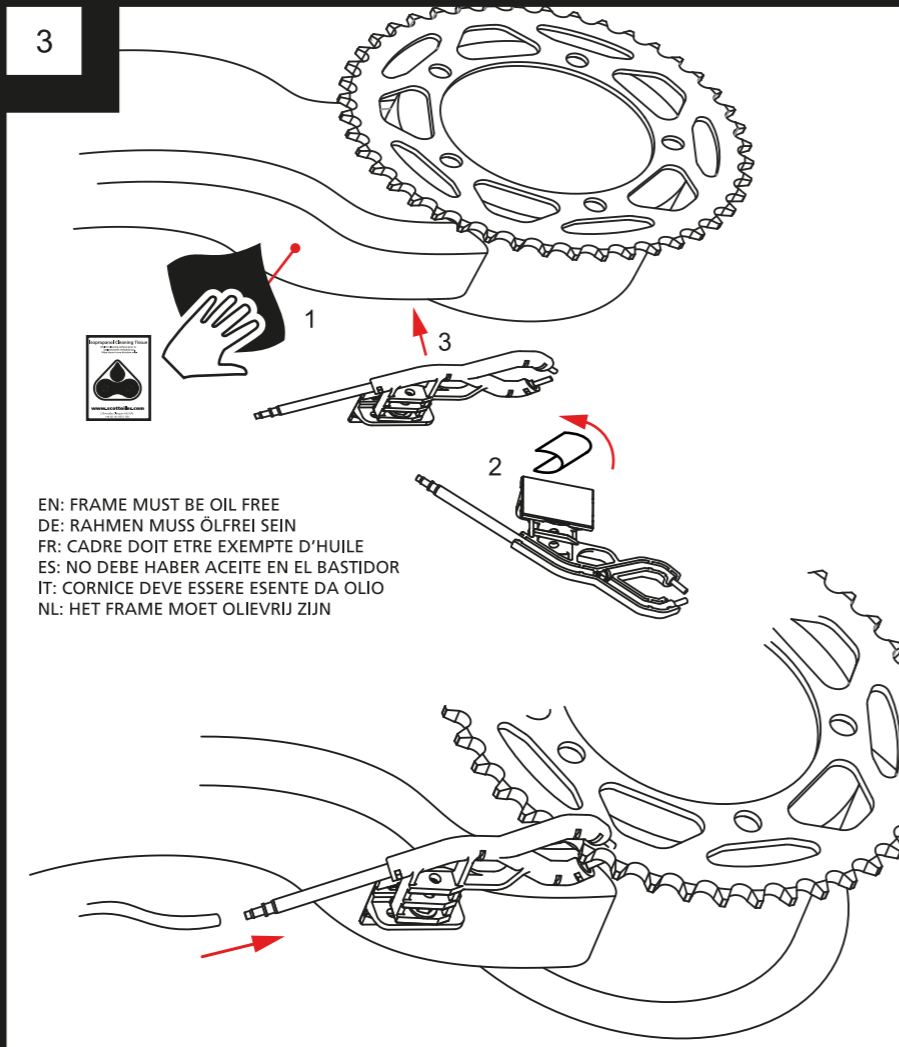

Tools Required

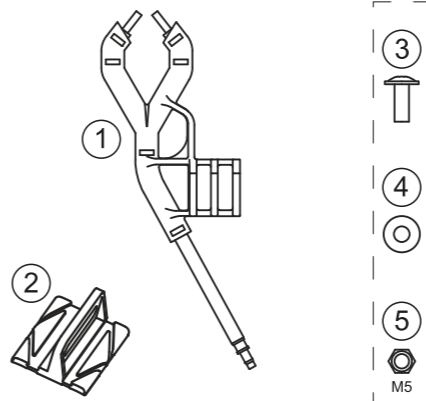
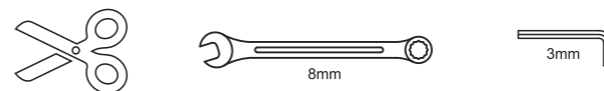

6 x2



7 x2



8 (100% IPA)



SCORPION Dual Injector

www.scottoiler.com

SCOTTOILER



register your product
www.scottoiler.com/warranty



installation videos
www.scottoiler.com/scorpion



installation guides
www.scottoiler.com/mybike

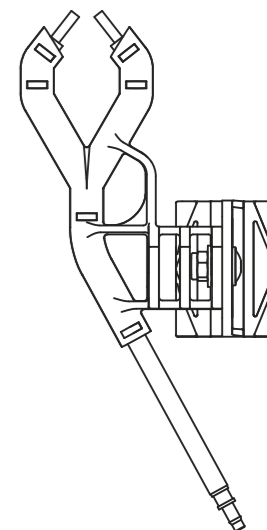

1

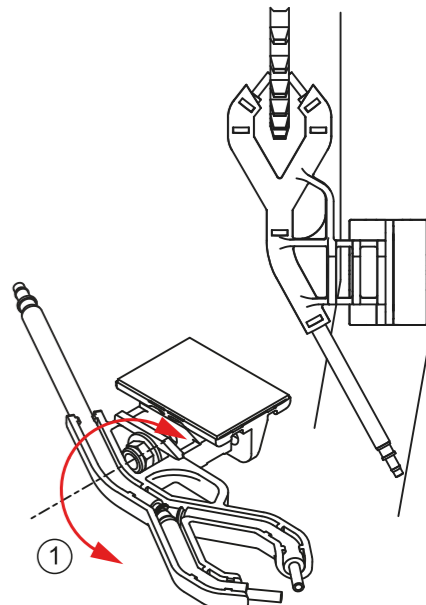
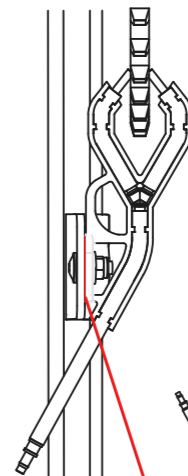
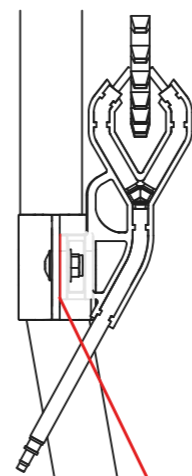
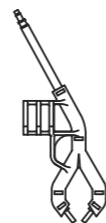
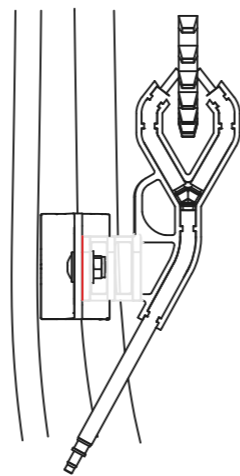
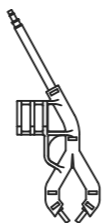
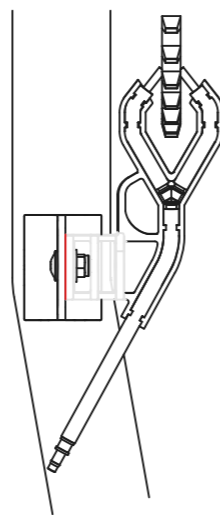
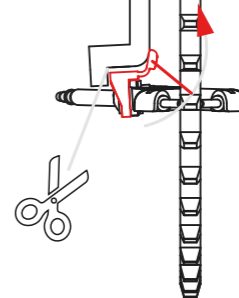
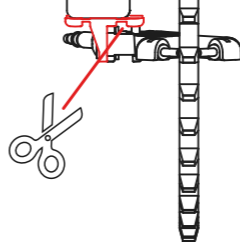
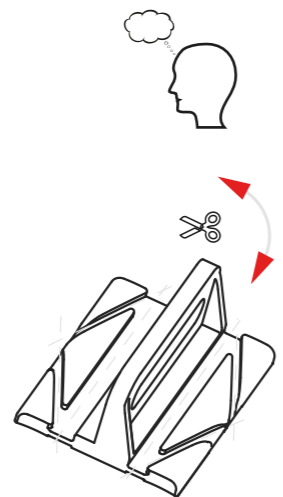
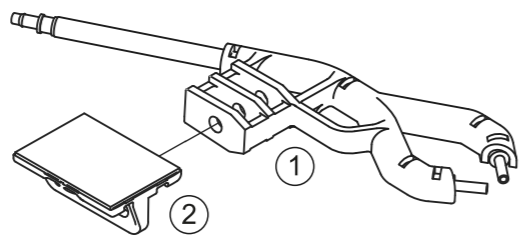
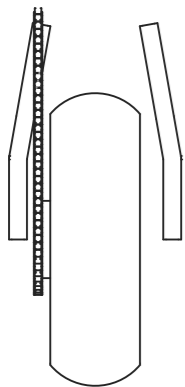

2

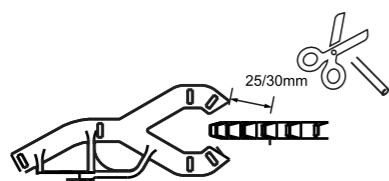
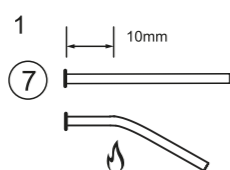
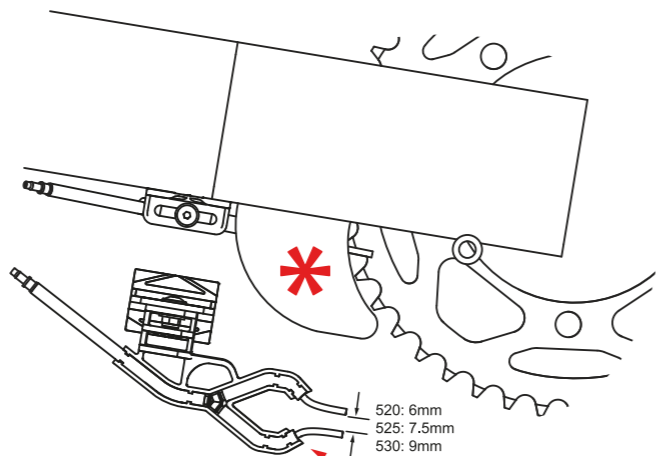
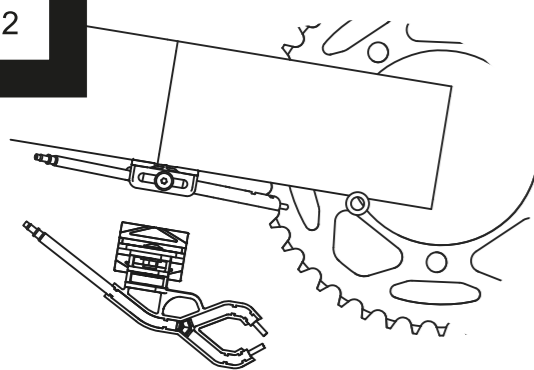

3

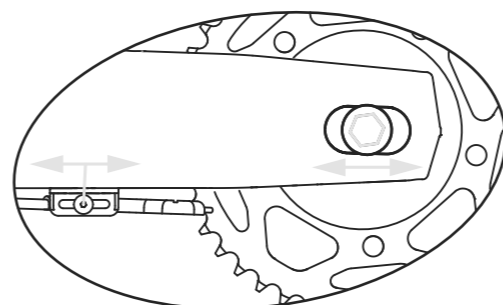

4

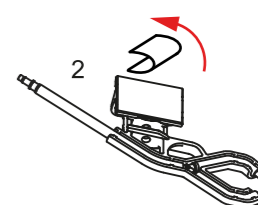
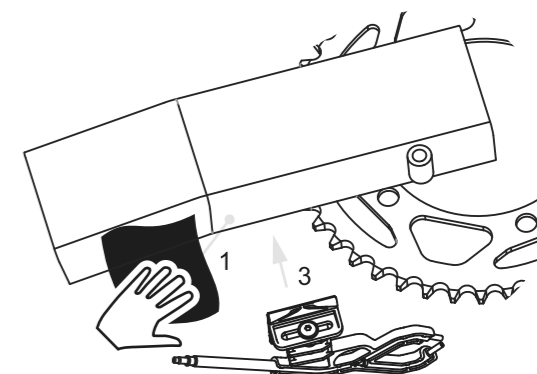

EN: FRAME MUST BE OIL FREE
DE: RAHMEN MUSS ÖLFREI SEIN
FR: CADRE DOIT ETRE EXEMPTÉ D'HUILE
ES: NO DEBE HABER ACEITE EN EL BASTIDOR
IT: CORNICE DEVE ESSERE ESENTE DA OLIO
NL: HET FRAME MOET OLIEVRIJ ZIJN

